

# FABSPACE

## HANGARS



# UNLIMITED. IN SIZE AND DESIGN.

At ARCITEX gmbh we are architects with a passion for innovative and sometimes unconventional solutions. In 2009, we set out to design an aircraft hangar that would meet the requirements of a large aircraft object, yet be mobile and temporary. Also, we wanted it to be an object that is readily available, easy to handle, and quick to set up. Our vision was to design a beautiful object that meets all the requirements for the protection of aircraft and can be installed on any surface. The FABSPACE HANGAR was born.

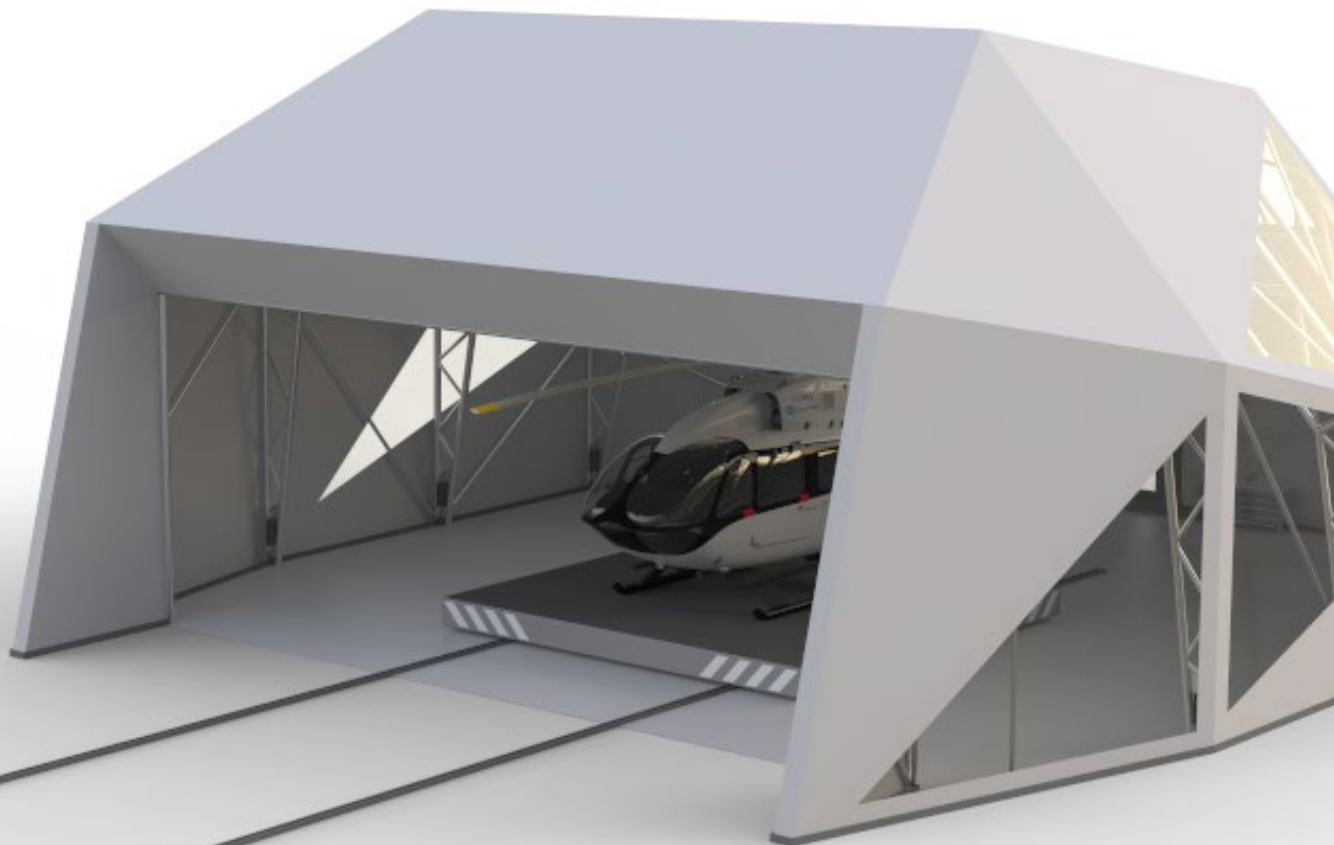



# FABSPACE HANGARS

---

All FABSPACE hangars are based on the idea of a temporary and mobile hangar system. As a modular concept, FABSPACE offers a new solution for aircraft and helicopters storage.

Using special textile facilitates a simple, yet sturdy structure which is easy to assemble, disassemble and store. It meets the highest quality standards as well as unmatched aesthetical principles.

By combining a lightweight frame construction and a textile membrane skin, FABSPACE is an exceptional protective covering for all types of aircraft and can serve many other uses on demand.

In 2009, Red Bull became aware of our project and approached us for a partnering effort during Austria's AIRPOWER 2013: Hangar V\_01, the prototype of ARCITEX's hangar, was selected to house the very first public presentation of Red Bull Stratos, the associated space capsule and Felix Baumgartner.

---

Produced exclusively in Austria and central Europe, FABSPACE hangars combine efficiency and technical sophistication.

To meet also the highest standards in design, we cooperate with one of the most renowned industrial design studios in Austria. The unique design is influenced by diamond structures and stealth planes.

Our lightweight steel construction and hot-dip galvanized truss structure is set on a metal foundation which can be fixed to any kind of surface – whether you need to build a hangar in the desert or on a perfectly flat asphalt or concrete surface, FABSPACE is the ideal solution for you.

The special membrane cover by market leader Serge Ferrari, France, facilitates easy assembling and disassembling and combines functionality with design.

The FABSPACE hangar is earthquake-proof, can withstand winds from 150-250 km/h and carry a snow weight from 150-250 kg/m<sup>2</sup>. These features guarantee maximum protection for your valuable equipment. Whether in the Austrian Alps or in a crisis area, the FABSPACE hangar concept is your best choice to protect your aircraft or helicopters or any civilian / military assets.

The fundament factors to the FABSPACE design concept were not only mobile use (fast installation and a simple and expedient disassembly) but also easy transportation in standardized 20 ft containers. With a relatively short production and delivery time of 6-8 weeks we make sure that your hangar reaches you wherever and whenever you need it. Once it arrives, our model V\_01 is under ideal conditions up and functional in 1 day.

## DESIGNED TO MEET YOUR INDIVIDUAL NEEDS

All of our hangars can be customized to meet your individual needs and protect your valuable assets.

If you need a hangar for your off-shore business on the coast, we can make it. If a helicopter rescue team needs a hangar in the mountains, we will customize it according to their needs. The sizes as well as all features of the FABSPACE hangar are tailorable to meet your special requirements.

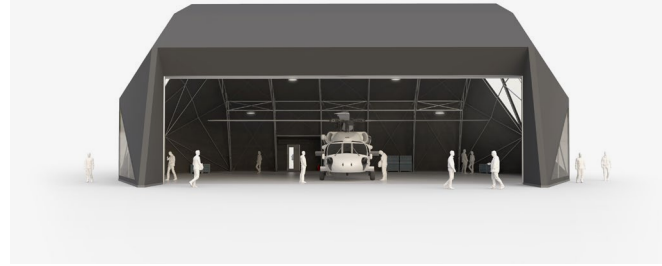
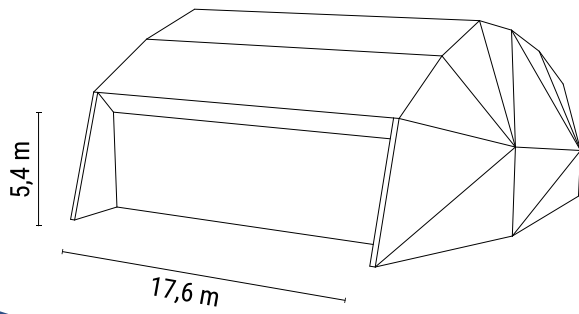

## DIMENSIONS

Dimensions:	W/	25.00 m
	L/	28.00 m
	H/	10.60 m
Floor area:		580 m <sup>2</sup>
Gate measures:		17.6 m x 5.4 m

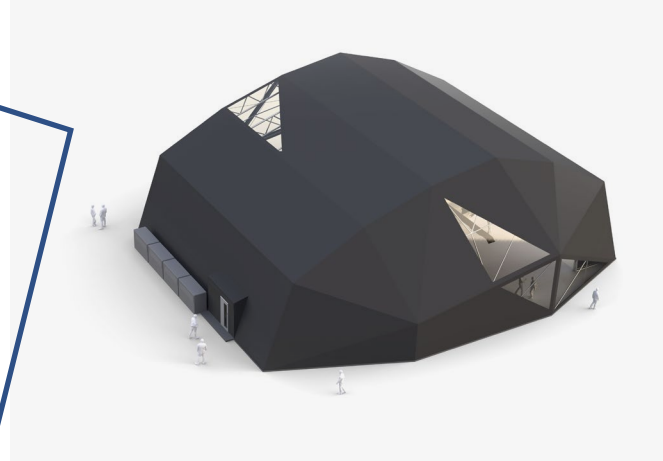

## V\_03

The V\_03 hangar was designed for medium to big helicopters.  
(i.e. UH 60 Blackhawk helicopter, etc)

Equipped with an electrical moving membrane door (door width 17.6 m / door height 5.4 m).

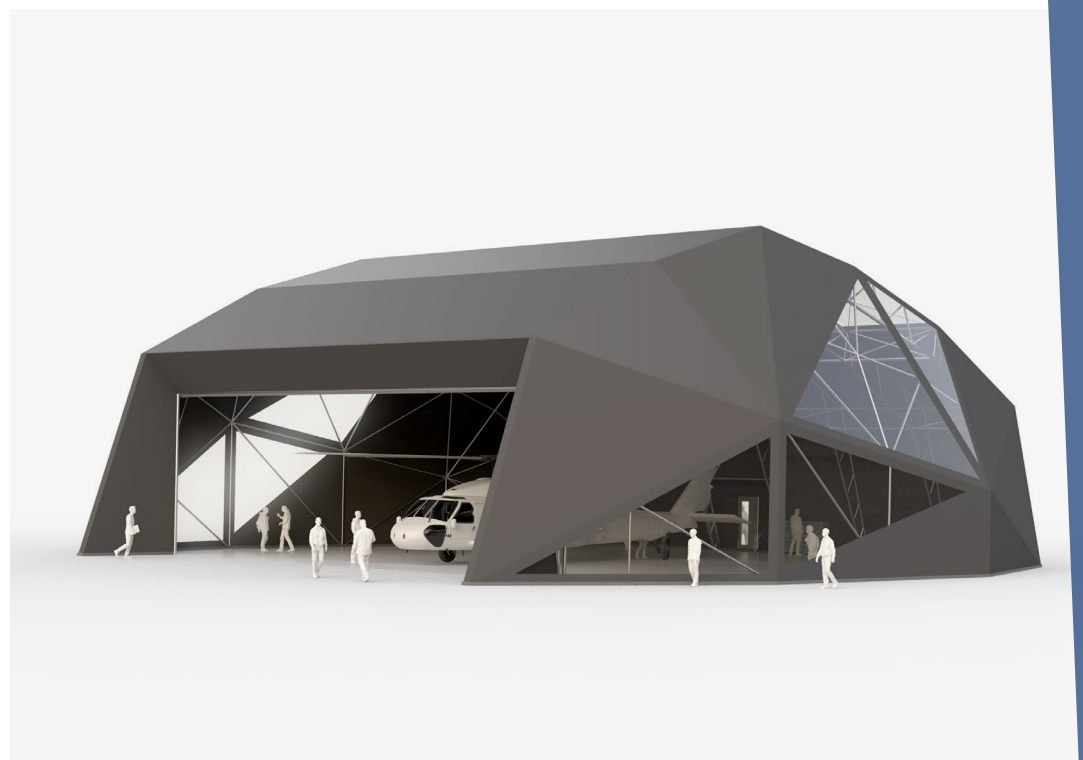

# SERVICES / CUSTOMIZING

We can customize your own hangar in size, design and function.

We can produce every color.

We can print your company name in each design and size.

We can customize your hangars with technical equipments and features.

You can buy, rent or lease a FABSPACE HANGAR for your off shore business, your special use or for an economic financial business.

Our services include the planning and design of your hangar with all documents necessary: once your order is placed, you will receive all documents required as well as all certificates and static reports needed.





## DELIVERY

Each FABSPACE hangar is shipped and delivered to you in 20" or 40" standard containers by truck, ship, train or by a transport aircraft. Our team professionally installs your hangar and can also train your staff how to assemble and disassemble. This option is particularly interesting should you decide to order and store your FABSPACE hangar on site in your own container and have your staff build it upon short notice.

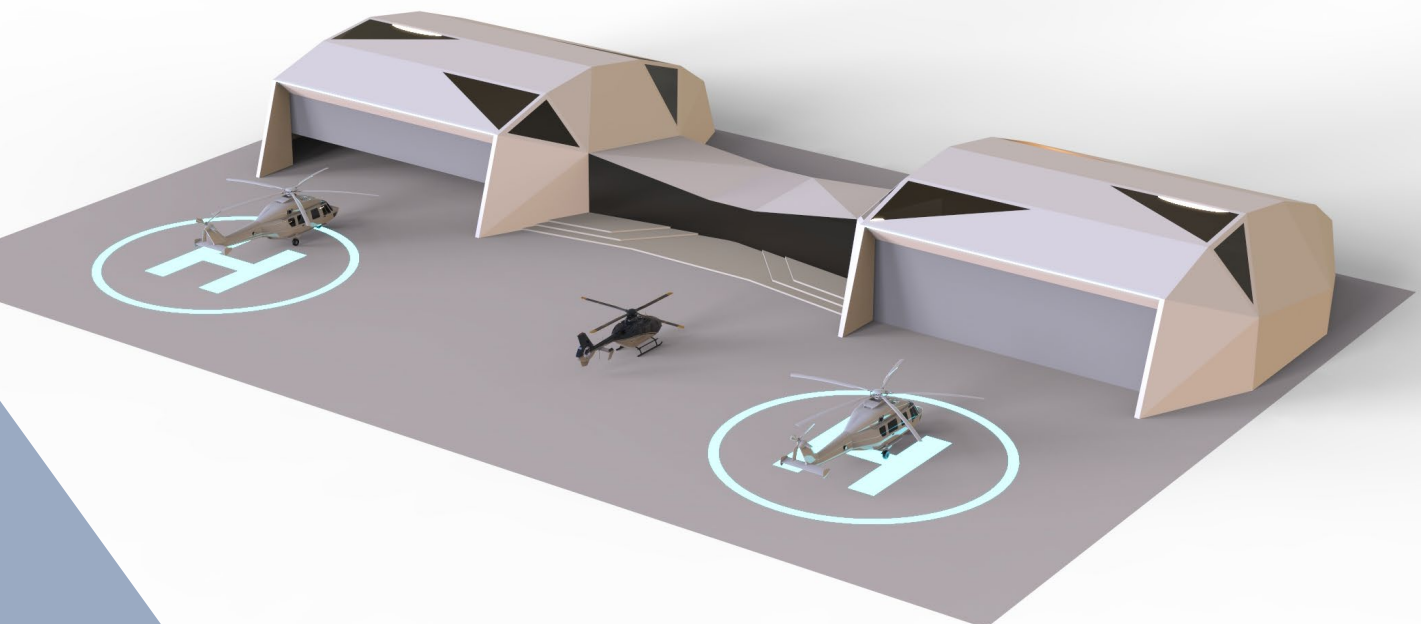
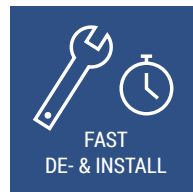

# TECHNICAL INFORMATION

The skeleton of each FABSPACE hangar consists of a lightweight hot-dip galvanized truss steel structure, which is then set on a special foundation made of steel.

SERGE FERRARI membrane protects your valuable assets against sand, hail, rain or snow.

For our standard hangars, 7 different membrane colors are available and can be branded with your company logo. Should you wish to give your hangar an even more individual touch, color and design can be further customized according to your needs.

All components have been thoroughly tested and a concept book with planning documents, certificates and building specifications is available. Upon handover of each new hangar, a final report is handed over to the owner to be submitted for a facility audit.

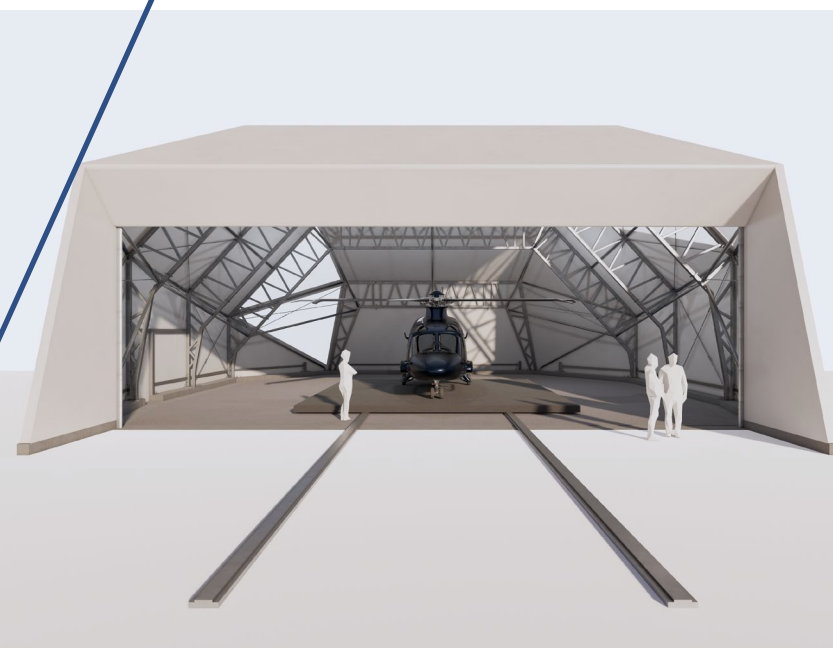
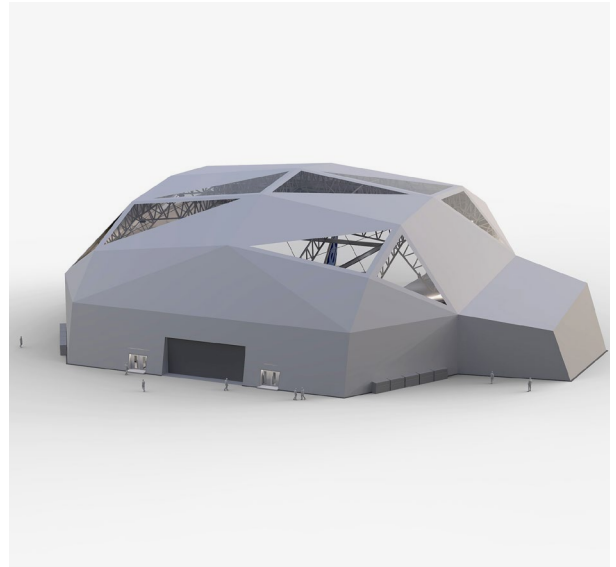

## CONSTRUCTION

The construction is designed for many different solutions. To handle with man power on different places on each surfaces, the construction parts are designed in such a way that they can be transported in one or more containers of 20" or 40" size.

You can order the FABSPACE HANGAR in your own container to rebuild and store the hangar solution as soon as practicable for different applications.

Please note that every basic FABSPACE hangar is earthquake-proof, can withstand winds up to 250 km/h and carry a snow weight of up to 250 kg/m<sup>2</sup>. The construction can be fortified further according to your needs.



# MATERIALS

Fabspace hangars are produced in Austria and Europa using high quality materials and hightechnical performances.

All materials used to set up a FABSPACE hangar are compliant to the European standard norms for fire and smoke reports and fulfill all static requirements for wind-, snow- and earthquake-certificates.

Our partner, Serge Ferrari, is world leading manufacturer of membranes with the unique offer of Précontraint. Ferrari's membrane collection Flexlight is available in three different weights, depending on the size and the purpose of the hangar:

Flexlight Perform 702S2, a light membrane (750 g/m<sup>2</sup>)

Flexlight Perform 832, a middle weight membrane (850 g/m<sup>2</sup>)

Flexlight Advanced 902 S2, a heavy weight membrane (950 g/m<sup>2</sup>)

## HEAT MANAGEMENT

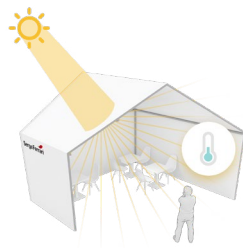

Thermal comfort with double translucent membrane.

## 100% OPAQUE MEMBRANE

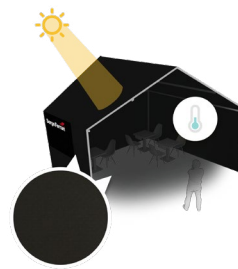

Protection of UV sensitive products and a good thermal comfort.

## FIRE PROTECTION

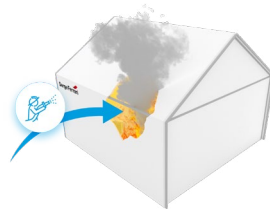

Self-extinguishing, flame retardant, smoke evacuation ensurement and effective heat control.

## LIGHT TRANSMISSION

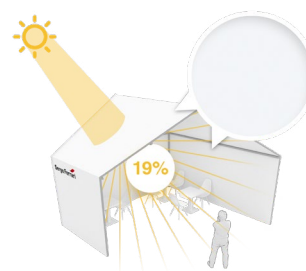

More comfort for users with more safety and less energy costs.

**Serge Ferrari**



## LIGHT & ELECTRICAL EQUIPMENT

All our hangars are delivered with an electrical and a light system. The power unit contains a LED light system as well as the electrical connection for the hangar door including a distribution box.

The basic version of all FABSPACE hangars comes with an electrical moving membrane door and one or two smaller pedestrian doors. If required, customized solutions for doors of all sizes and types can be delivered.



## FEATURES & DOOR APPLICATIONS

All hangars in our FABSPACE family are basically installed with an electrical moving membrane door in the noted door-size and one or two pedestrian doors on the side.

We can offer various solutions like aluminum and membrane doors from different well-known suppliers.

Special solutions in size and design up to 40 m wide and 15 m high are possible to integrate.



# ADDITIONAL EQUIPMENT & ENHANCEMENT OPTIONS

Additional heating or cooling solutions as well as accessories such as alarm systems, generators, etc are additional options. Separate work and office space inside the hangar can be planned individually.



## MAINTENANCE OPTIONS

We can help you with planning the optimal solution for servicing and maintenance sections.

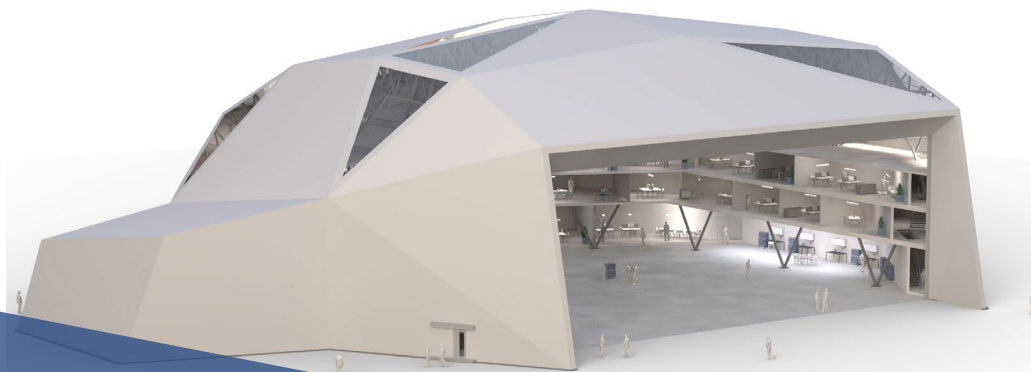

# INSPIRED BY FABSPACE

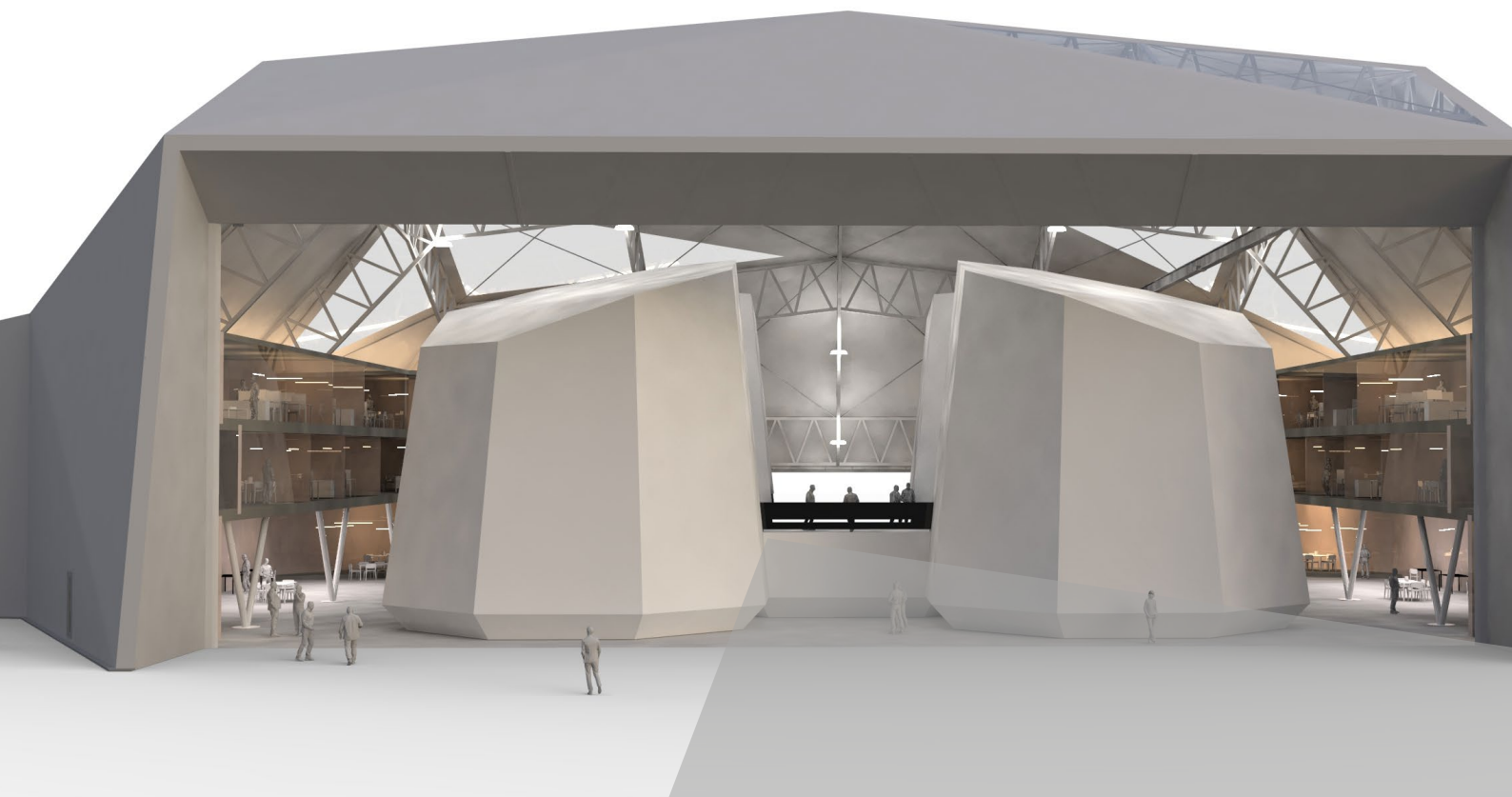
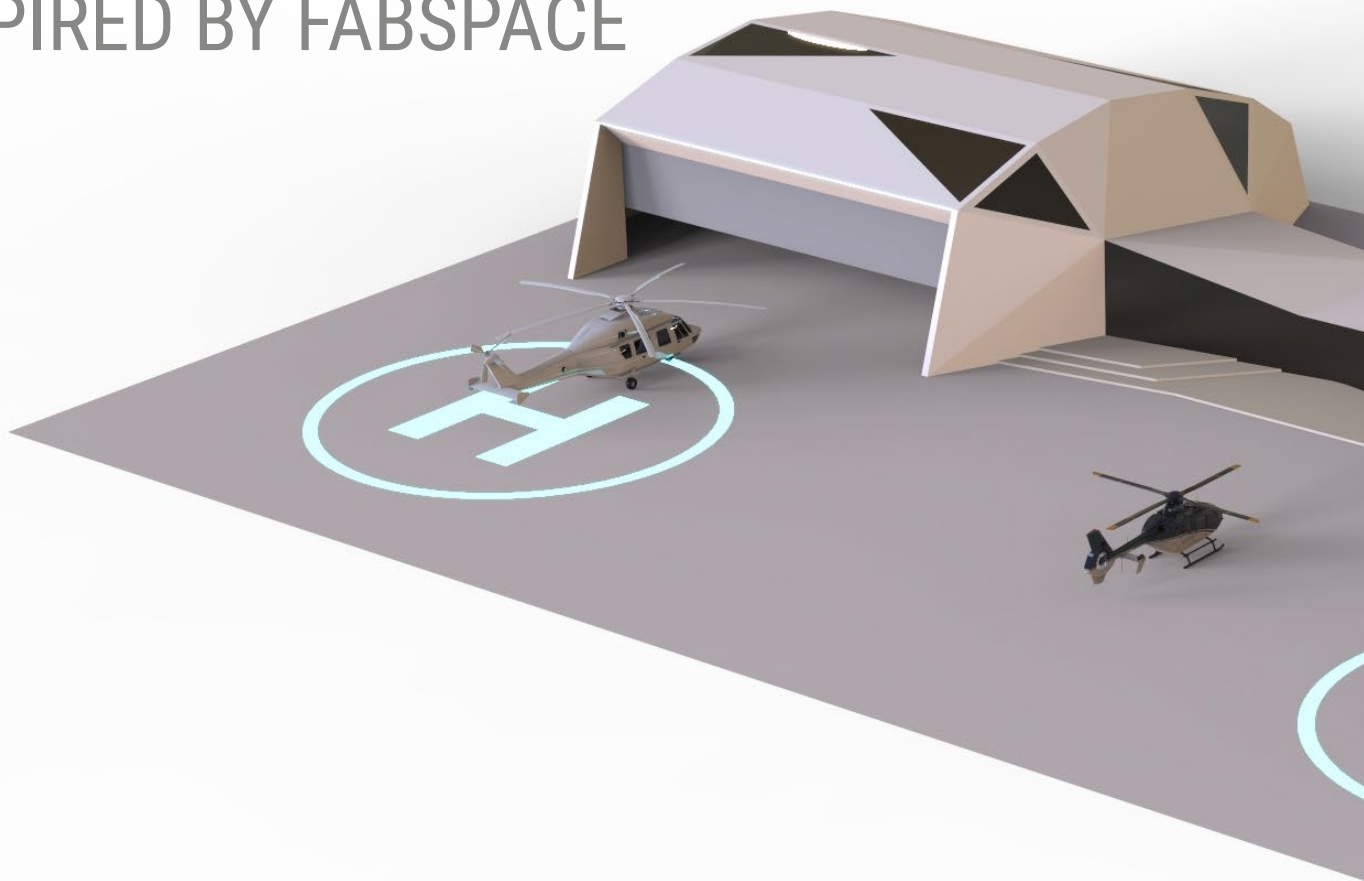

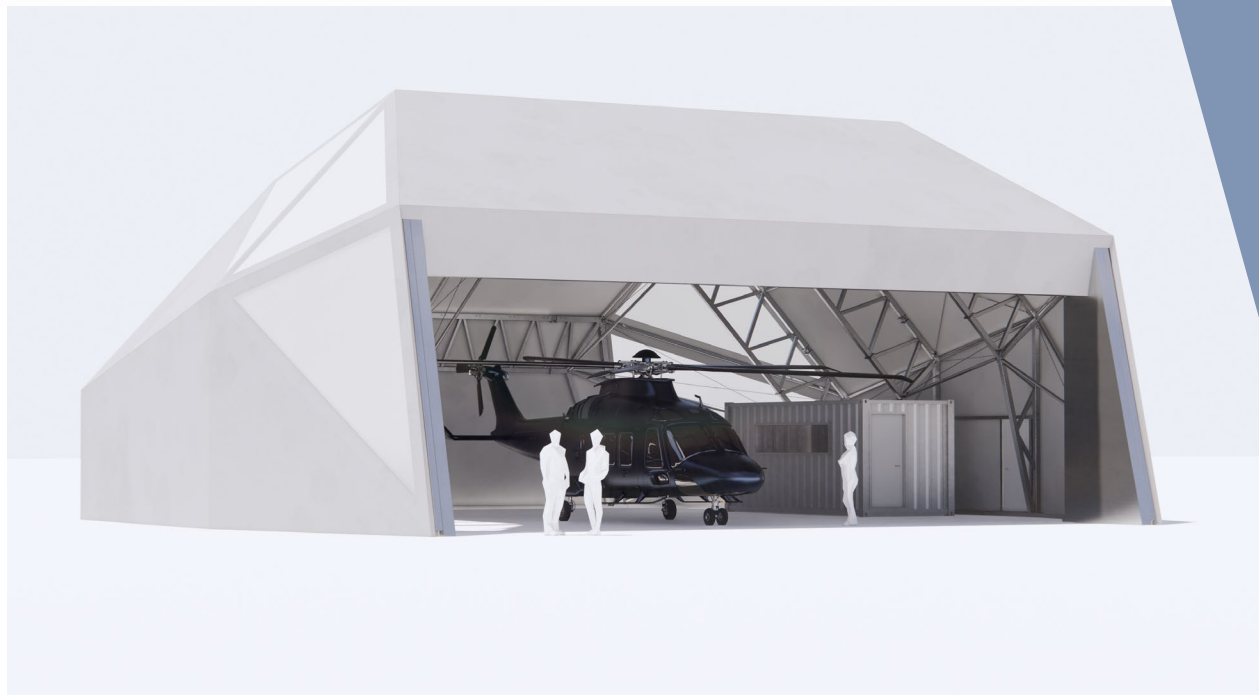
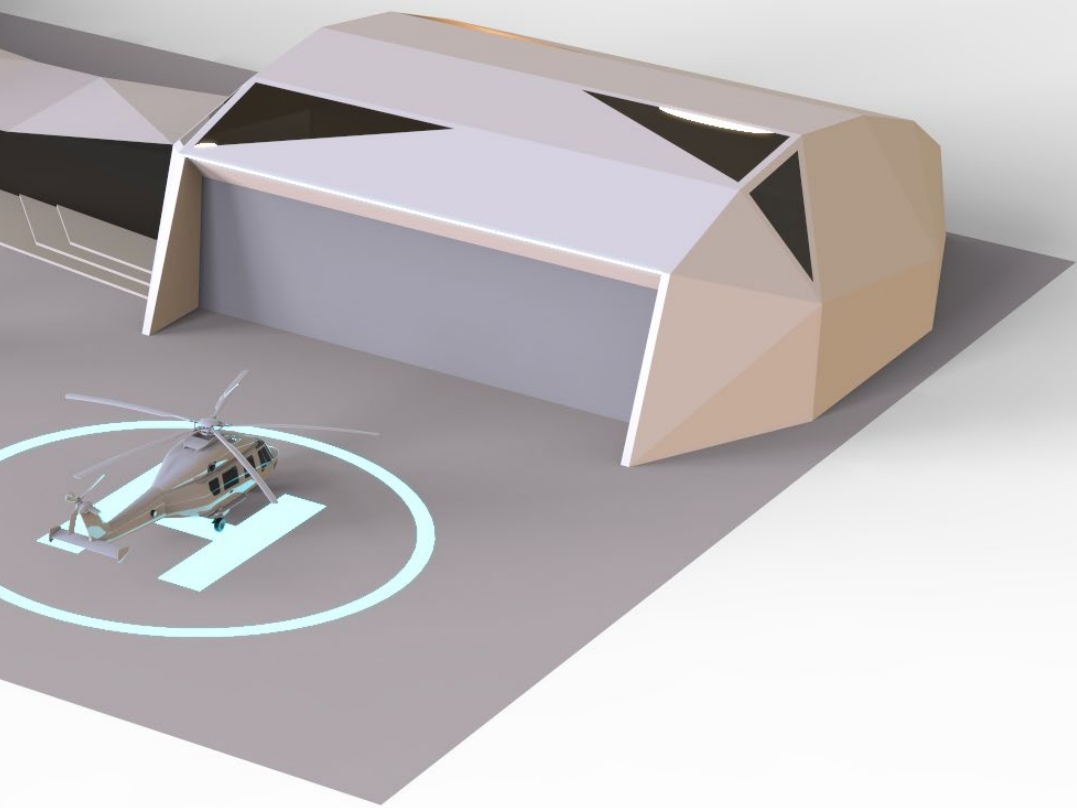



## TEAM

---

Franz F. Kühberger  
Fabspace Hangars | CFO & Owner  
+43 676 32 32 710  
fk@fabspacehangar.com



Miguel Klein  
Fabspace Hangars | CEO & International Sales Director  
+43 660 10 16 305  
mk@fabspacehangar.com

## FABSPACE EUROPE & GCC STATES

---



Mats Olofsson  
FABSPACE hangars | Scandinavia (DK, FI, NO, SE) & Baltic states  
+46 708 541 878  
mats@fabspacehangar.com

Johanna Olson  
+46 76 173 17 33  
johanna@fabspacehangar.com



Alan Ward  
FABSPACE hangars | UK & Ireland  
+44 7508 401498  
alan.j.ward@btinternet.com



Gianfranco Di Maio  
FABSPACE hangars | Italy & GCC  
+39 335 656 5945 | dimaio@helipad.it  
Office Italy: Via Bandiera 2, 90133 Palermo, Italy

+971 50 9813384 | dimaio@helipad.it  
Office GCC: Salem AL Mubarak Street, Block 20, Building 34, Office 10,  
First Floor, AL Anjari Building, Salmiyah, Kuwait





# FABSPACE WORLDWIDE



Bettina Klein  
FABSPACE hangars | Asia  
+43 664 789 56 36  
bk@fabspacehangar.com



Augusto Veliz Peña  
FABSPACE hangars | South America  
+56 9 4427 0244  
avelizp@gmail.com  
Office: Santiago de Chile, Chile



Alvaro Irigoyen  
FABSPACE hangars | South America  
+56 9 8139 9395  
airigoyen@discoveryair.cl  
Office: Machalí, Chile

## CONTACT

Our team is looking forward to hearing from you – whether you want to buy, rent or lease a FABSPACE hangar, we are sure they will be able to meet your needs.

### Headquarter Austria:

Arcitex gmbh textile architecture & hangars  
Blumauergasse 34, A-4400 Steyr  
+43 7252 42 43 410  
ATU 677 306 09 – FN 392058g – EORI ATEOS1000063218  
CFO Franz F. Kühberger – CEO Miguel Klein  
office@fabspacehangar.com / www.fabspacehangar.com  
instagram.com/fabspace\_hangars  
facebook.com/fabspacehangar

### Sales Office Austria:

Fabspace Hangars  
Ölzeltgasse 1, A-1030 Vienna  
CEO Mr. Miguel Klein

### Showhangar Austria:

Int. Airport Linz Hörsching - Flughafenstraße 1 A-6840 Hörsching





FABSPACE  
HANGARS